

# Navigation Light Controller with Mimic interface

Manual\*

Rev. 1.2  
December 2020

Mimic panel(s)



Navigation Light

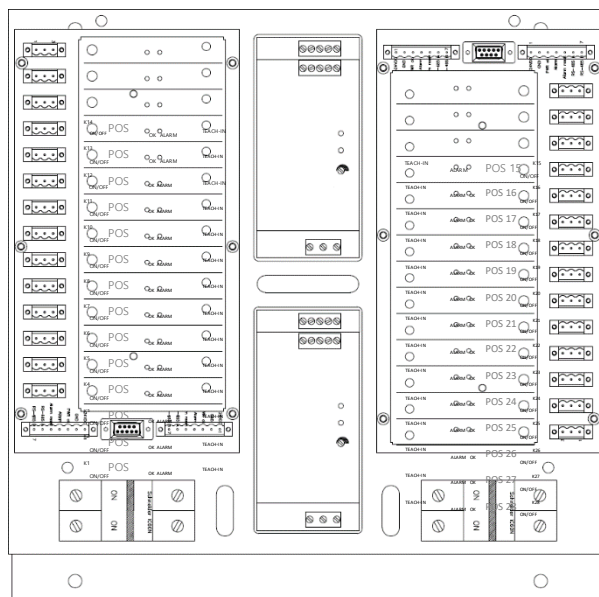

\*) This manual shall be read together with the software manual for the Mimic interface

**Table of contents:**

<u>Section:</u>	<u>Page:</u>	<u>Text:</u>
1.0	3	Preface
1.1	3	Modular principle
1.2	3	Basic working principles
1.3	4	System overview
2.0	5	Standards and resolutions
3.0	5	Navigation Light Controller (NLC) basic data
3.1	5	Mimic panel basic data
3.2	6	Controller power and connections
3.3	7	Navigation light controller (NLC) installation guide
3.4	8	Mimic panel installation guide
3.5	8	Controller, direct control (emergency operation)
3.6	10	Controller schematics
4.0	11	Controller service and maintenance
5.0	12	Connection NLC to TCP/IP server
6.0	13	Initial installation and set-up
6.1	15	First time set-up
6.2	15	Teach-in
6.3	17	Manual control of lights
6.4	17	Factory reset
6.5	17	Setting the address of the LMR/Qs
7.0	20	Spare parts list
8.0	21	Replacing power supplies in the NLC
9.0	24	Replacing LMR card
10.0	27	Troubleshooting guide and instructions
11.0	28	Exploded Illustration of NLC components

## 1.0 Preface

The Lopolight Navigation Light Controller (NLC) and Mimic panel(s), described in this document, is a simple to install and simple to operate system, that can control up to 60 pcs. Lopolight navigation lights.

The system is based on the type-approved Lopolight Monitoring Relay (LMR/Q). Refer to section 2.0 for further information concerning approvals.

### 1.1 Modular Principle – up to 60 outputs.

The core NLC controller consists of up to 14 outputs (navigation light connections), and can be extended with 14 additional outputs, totalling 28 controllable outputs.

If more than 28 channels/ connections are required, multiple systems can be installed in parallel. The mimic panels are available in different sizes to fit most requirements.

### 1.2 Basic working principle

The complete system consists of four basic components:

#### 1: The NLC

The NLC holds the LMR/Q monitoring relays, primary power-supply, secondary (emergency) power-supply, and navigation light connection terminals as well as connection for the TCP/IP server.

#### 2: TCP/IP server

The TCP/IP Webserver secures an easy communication between the NLC and the mimic panel via DisplayPort/HDMI and USB connections. If the system contains more than one mimic panel, an Ethernet connection/switch must be used.

The client converts ethernet data to HDMI/USB/RS232/NMEA0183 communication formats to connect the mimic panels. In principle, an unlimited number of mimic panels could be connected to the system.

#### 3: TCP/IP alarm client

The TCP/IP Alarm client secures an easy communication between the TCP/IP Webserver and the mimic panel

#### 3: MIMIC PANEL

The Mimic panel offers a graphical user interface for full operation and setup of the complete NLC system. Lopolight offers a range of mimic panels to fit most requirements. See separate

data for mimic panels.

The NLC can also be interfaced with any monitor/mimic panel on the Vessel, as long as this equipment contains a normal web browser.

Multi-processor principle:

The controller holds one or multiple Lopolight Monitoring Relays (LMR/Q's), these are the basic components in the system. One LMR/Q is assigned to each individual output.

Each LMR/Q is assigned a logical address that can be controlled by a data telegram from the controller (panel or similar). The multi LMR/Q processor principle offers the highest possible degree of redundancy as every navigation light is monitored by a separate monitoring Relay.

### 1.3 System overview

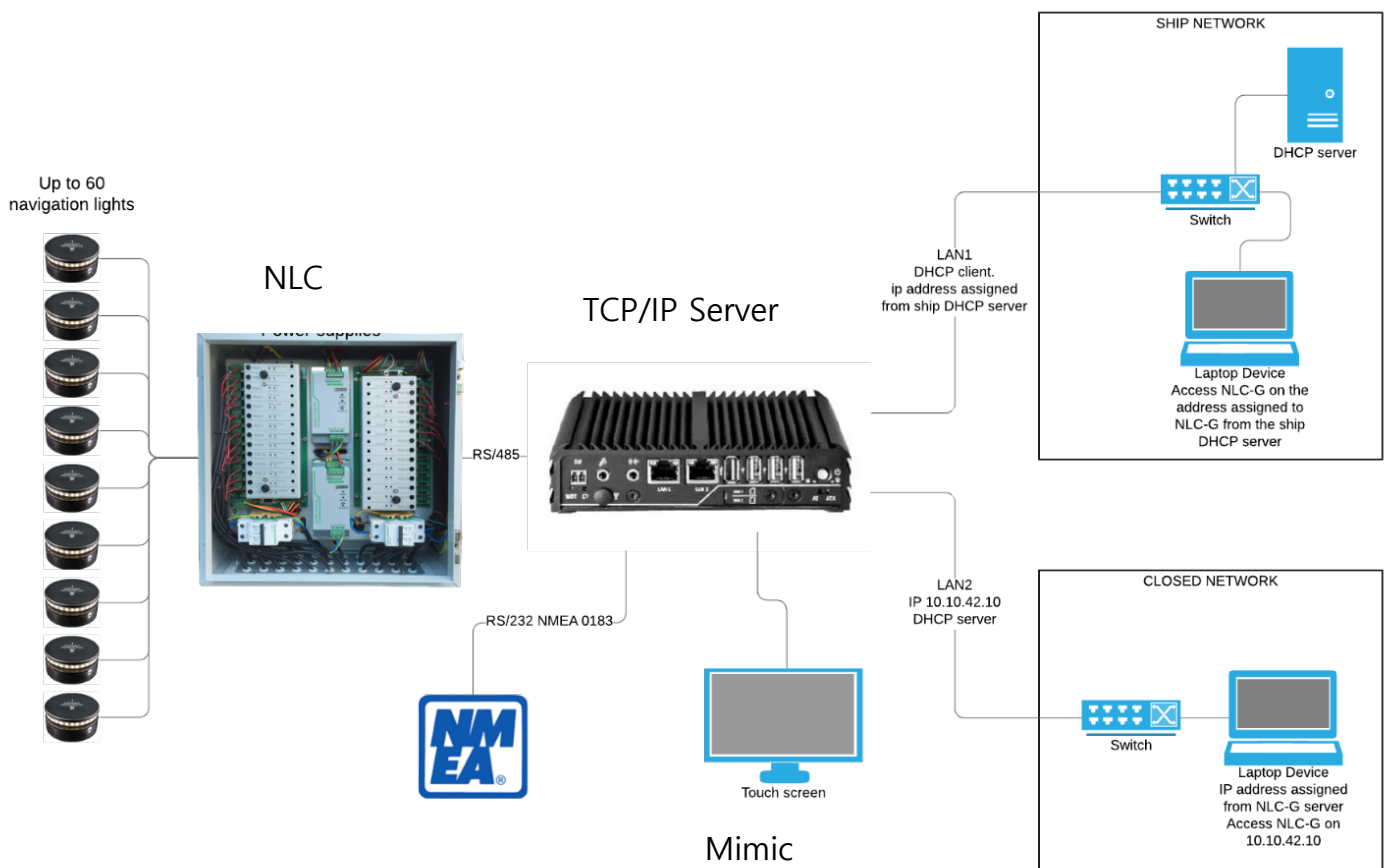

## 2.0 Standards and resolutions

The system meets and exceeds the following standards, type approvals and resolutions:

Lloyds register type approval: 12/70035\*

IEC-60945 / EN-60945

MSC 253(83) Annex 31

MSC 79/23/Add.2 Annex 33

IEC 62288

IEC 61162-1

\* LMR/Q: Type approved by Lloyds register: certificate #: 12/70035

Approvals can be downloaded at: <https://www.lopolight.com/NlcPanel>.

## 3.0 Navigation Light Controller (NLC) basic data

Installed in cabinet;

Cabinet:	Steel enclosure (Schneider-Electric: Special S3D)
Dimensions (WxHxD):	400*400*200mm
Mounting:	4 wall screws (not supplied with system)
Weight:	~13 kg. (full version)
Ingress protec.	IP66 (depending on selected cable entry system)
Cabinet certificates:	BV, CUL, DNV, GL, LR, UL
Colour:	RAL 7035 (Light grey)

Protective ground connection: M6 bolt connection protruding from cabinet

Theoretical temperature rise: 25°C. above ambient @ 200W load.

Open installation (without cabinet);

Dimensions (WxHxD):	354*350*148.5mm
Mounting:	4 wall screws (not supplied with system)
Weight:	~5 kg. (full version)
Ingress protec.	None, either install in sealed compartment or in Cabinet to achieve IP rating.

Protective ground connection: M6 bolt connection on base plate

Theoretical temperature rise: 25°C. above ambient @ 200W load.

### 3.1 Mimic Panel, basic data

See separate datasheet

## 3.2 Controller power and connections:

### Inputs;

Primary power-supply, *Option A*: 100-240VAC 50/60Hz, Maximum 250W

Primary power-supply, *Option B*: 19-32VDC, Maximum 250W

Sec. power-supply, *Option C*: 100-240VAC 50/60Hz, Maximum 250W

Sec. power-supply, *Option D*: 19-32VDC, Maximum 250W

Internal circuit protection: 100-240 VAC: 6A[C], 19-32 VDC: 20A[C]

Connections: Elevator type screw terminals: 1.5 - 6 mm<sup>2</sup>

Isolation: Power supplies are galvanic isolated from vessel installations.

### Outputs;

Number of nav. light connections: Up to 28 LMR/Q\* based outputs.

Max. output voltage: 32VDC

Max. output current: 1 Amp per output – automatic current limiter.

Fuse: One 7A on-board (LMR/Q) fuse per output. (Non-replaceable).

Max. total output: 220W (total max. consumption must be calculated)

HW alarm output Relay: Max. 1A. normally open contact.

Power supply to TCP/IP server/client & mimic panel(s): 24 to 32VDC, max. 1,5A via data connectors.

### Data communication;

Physical: RS-485: 38400, N,8,1

Data protocol: Lopolight LMR/Q protocol

Data comm. interface option 1: 5-pin screw terminal plug

Data comm. interface option 2: 7-pin screw terminal plug

Termination resistor: 120Ω in screw terminal. Normally located in NLC. Use only one per system.

### TCP/IP Server;

Seatronx MPC-101-LOPO (See separate data sheet).

### TCP/IP Alarm client:

Seatronx MPC-101-LOPO (See separate data sheet).

### Mimic panel;

Lopolight offers a range of Marine graded mimic Panels in different sizes.

See separate data sheets for the various models.

### 3.3 Navigation light controller (NLC) installation guide

#### Placement;

The controller must be installed in a protected\* environment at bridge level and is recommended to be installed on a vertical surface (wall mounted). (\* refer to EN 60945/IEC-60945 in section 8.2)

#### Accessibility;

The enclosure door must be reachable, and it must be possible to open it fully to gain access to the manual (emergency) control buttons. It must be possible to gain full access to the manual control buttons within 2 minutes.

#### Temperature;

Ambient temperature range: -15°C to 50°C

NB! Avoid placing the controller near other equipment that creates excessive heat.

#### Mechanical;

Secure to bulkhead/wall using four pcs. of min. 10mm bolts. Ensure that the bulkhead/wall is suitable of carrying a load of 13 kg – also under heavy vibration.

#### Power supply;

Ensure that proper cable types and dimensions are used for the power-supply/supplies. Refer to section 3.1 for details (suggested minimum cable dimensions is 2.5 mm<sup>2</sup>)

#### Cable entries;

Power, communication and output cables must be strain relieved externally, in accordance with "good workmanship practise" and relevant standards.

#### Output cable installation – internal;

Connect the individual cables to relevant output plug/terminal using appropriate ferrules to protect the wire strands.

Ensure correct polarity (L+ = positive, L- = negative).

Scr. = screen/protective earth should be connected to cable screen, unless cable screens are ground connected elsewhere near the controller.

Secure plugs with screws before finishing installation.

Recommended cable dimensions: 0.5 to 2.5 mm<sup>2</sup>.

#### Output cables;

Output cables may be connected directly to the controller. If heavy-duty ships cables are used, it may be necessary to terminate these at an external terminal bar, and then connect the external bar to the output plugs of the controller using cables or wires with a smaller dimension.

If the controller is installed in an enclosure, cables should be drawn from the gland plate (fitted at the bottom of the enclosure) at the underside of the support plate and emerge just before the dedicated connector (K1-14)

#### Protective ground;

Protective ground must be connected to the cabinets or base plates ground point using proper sized grounding wire or mesh. (suggested minimum: 6 mm<sup>2</sup>)

**Compass safe distance: 0.5 meter (controller only).**

### **3.4 Mimic Panel, installation guideline**

See separate data sheet

### **3.5 Controller, direct control (emergency operation)**

The individual Monitoring Relay (LMR/Q) outputs can be controlled manually by a simple keypress. The output will toggle between on and off at every key press.

The output can be in three states: OK, ALARM and OFF

If an output is off, then the indicator will be off. If the output is on, the green "ok" indicator will illuminate. If the connected navigation light is faulty the red alarm indicator will illuminate.

The direct controls are independent from the mimic panel and are classified as "Manual Emergency Control". See section 6.2 for full details



Manual emergency

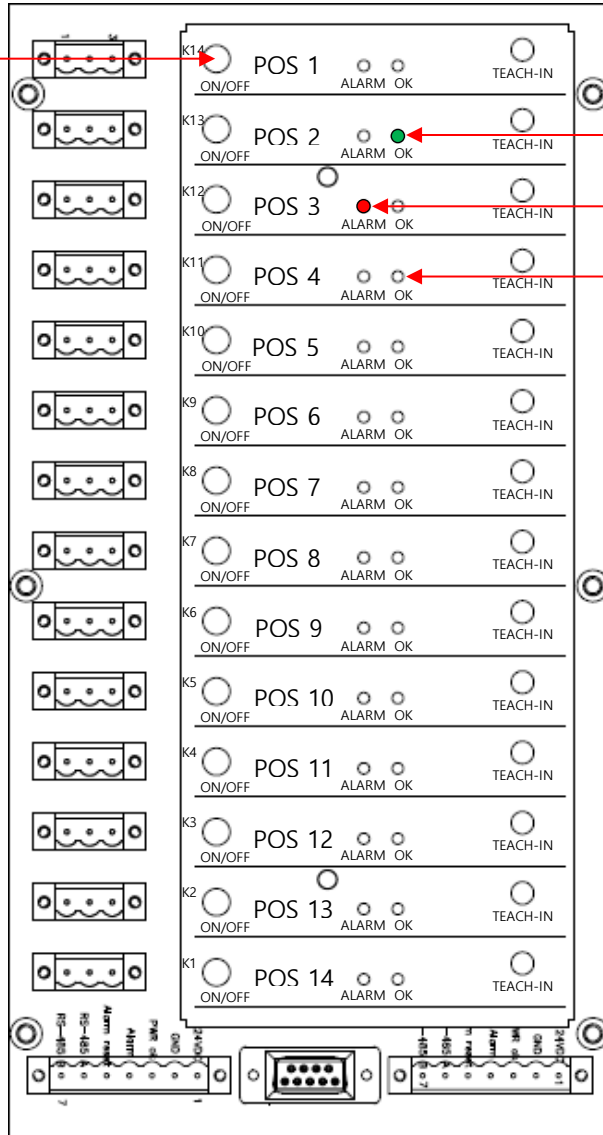

Output in OK state

Output in alarm state  
(faulty condition)

Output in OFF state

### 3.6 Controller schematics

Including power-supply and power monitoring function.

Note that the individual systems can have different power supplies as the system is offered with any combination of AC and DC inputs depending on project specifications.

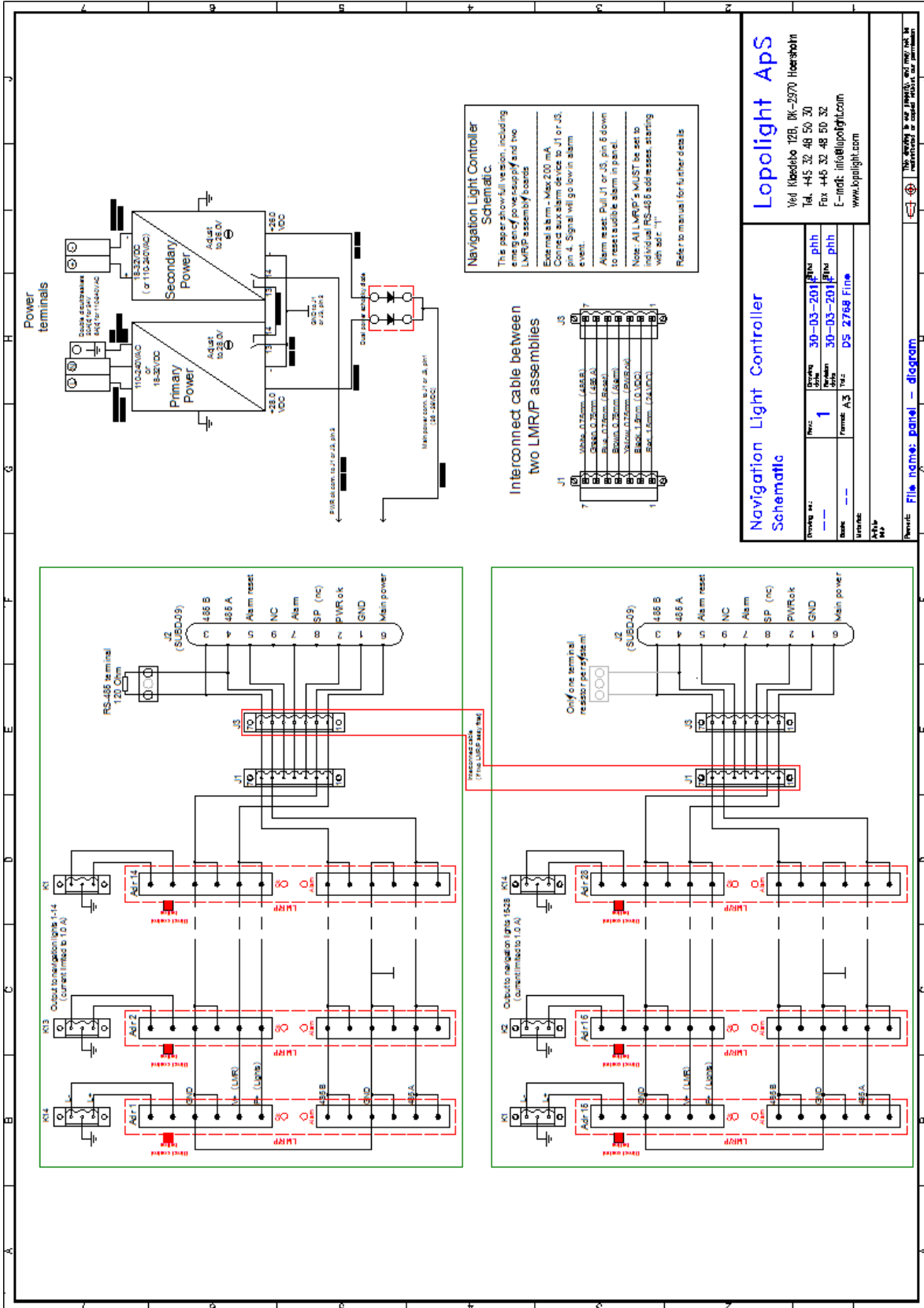

#### 4.0 Controller, service and maintenance

Adjustment of power-supplies; (only applies if redundant power-supply is fitted)

Using a digital multimeter set to DC voltage, measure across the any of the positive and negative output terminals on the power supply.

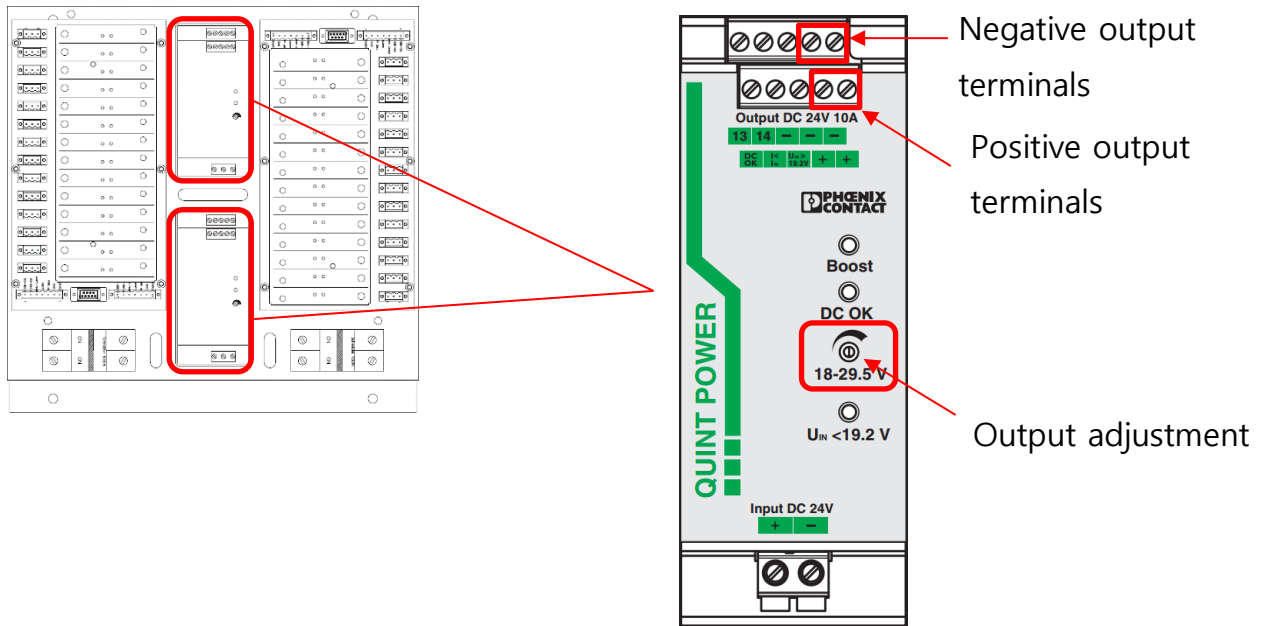

The power supply shown is a DC/DC, however the terminals and adjustment potentiometer are located in the same place on an AC/DC power supply

Adjust the power-supply in accordance with the listed outputs;

Primary power supply output: 26.2 VDC.

Secondary power supply output: 24.2 VDC.

LMR/Q replacement;

For replacing the LMR/Qs, please refer to the "Replacing the LMR in a Lopolight NLC" instructions.



## 6.0 Initial installation and set-up.

Protective ground connections - general guidelines:

The NLC must be connected to ships protective ground (hull) via the external grounding point, marked PE. Use the M6 terminal and appropriate lock washers to ensure good connectivity even under challenging circumstances.

If the feed wires to the individual navigation lights are of a screened type, then the screens must be connected to a PE point. This can be accomplished by using the middle pin on the 3-pin connector(s) for the lights or connecting to a PE point outside of the enclosure.

It is permitted not to use un-screened cables the last ~2 meters before the enclosure.

Hardware connections, NLC:

Make sure the two circuit breakers are open.

Connect the individual navigation lights to the NLC light terminals located along the right hand and left-hand side of the NLC.

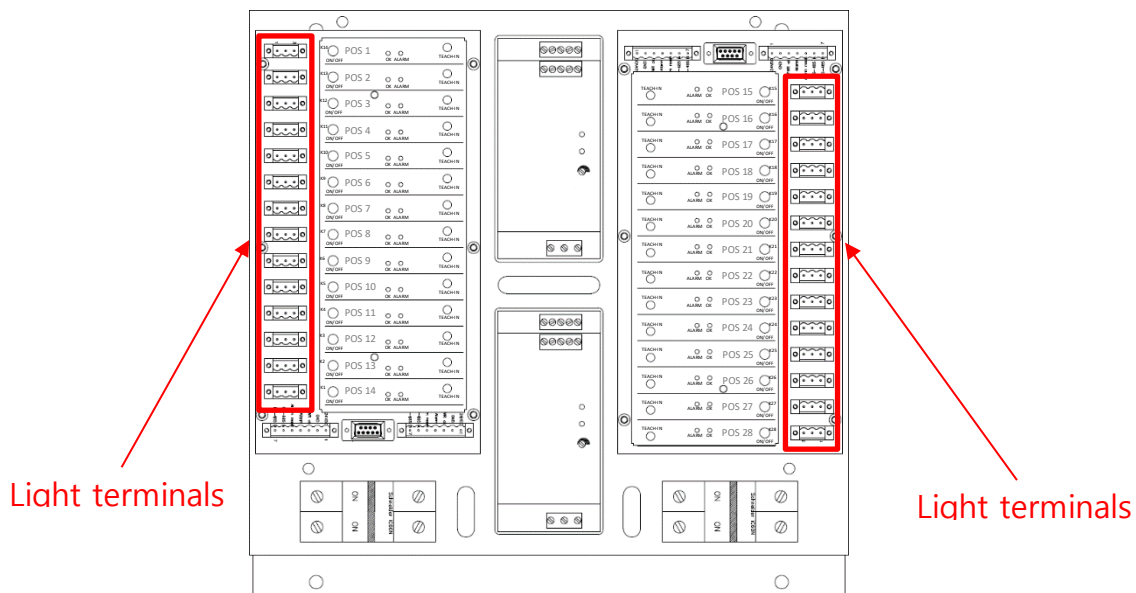

Connect primary and secondary power to the NLC.

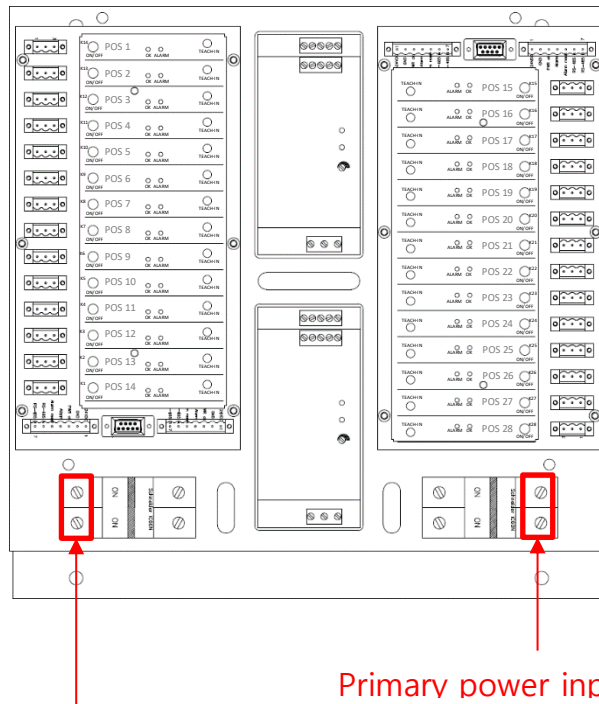

Primary power input terminals

Secondary/Emergency power input terminals

Connect the cables (depending on type) from the mimic panel to the TCP/IP server. If the TCP/IP server is placed inside the Lopolight enclosure, the connectors are found on the cable gland plate at the bottom of the enclosure

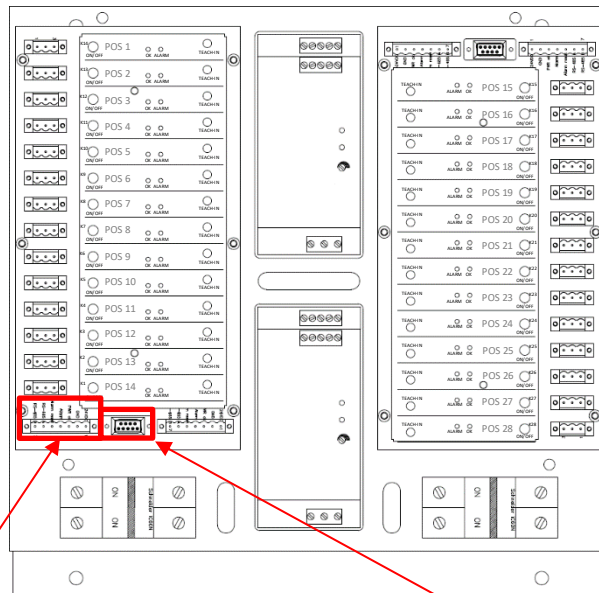

J2 - 9-pin Sub-D female connector

J1 - 7-pin terminal

Turn on system by closing the circuit-breakers. (Alarm will sound now. Can be silenced by pressing Alarm reset button on panel)

6) The system is now ready for first time setup.

### 6.1 First time Setup: *(also please refer to the software manual for the Mimic interface)*

All setup, including initial teach-in procedure, installing "ship image" file, naming lights, choosing icons type and positioning icons on ships image, pairing of lights, grouping of lights etc. Are all performed from the Lopolight software installed on the TCP/IP server.

To access the setup pages in the software, please refer to the "**Graphical interface software manual**".

Note! The setup pages in the software are password protected and to be used only by trained technicians.

### 6.2 Performing Teach In procedure:

Every LMR/Q must learn the individual characteristics of the light connected in order for the monitoring to be accurate and avoiding false alarms.  
Read more about the two types of LMR in 8.1

- 1) The Teach-in process makes sure that present consumption (in Watts) is stored in the local memory of the LMR for monitoring purposes.
- 2) Turn off all lights, using the individual control buttons.
- 3) Turn on the light connected to POS1 either using the control panel or the manual/emergency button located on the LMR, after lamp has been detected/startup flash, the alarm will sound and the LMR/Q turns red.
- 4) The LMR is ready to teach in after the LED turned red, activate the teach-in switch for POS1. (Insert a 2mm plastic pin or another non-conductive item and pry carefully to activate the switch. During teach-in, the LED on the front of the LMR/Q will flash yellow. (When teach-in is complete, the alarm will turn off and the OK LED will light up.)

If activating the teach-in button proves troublesome, it may help if the LMR/Q cover is removed to ease the access to the teach-in buttons. During the teach in, a yellow light will flash on the LMR/Q, it turns green when teach in is complete.



- 5) Turn off the light connected to POS1.
- 6) Repeat step 2 through 5 for all installed positions.

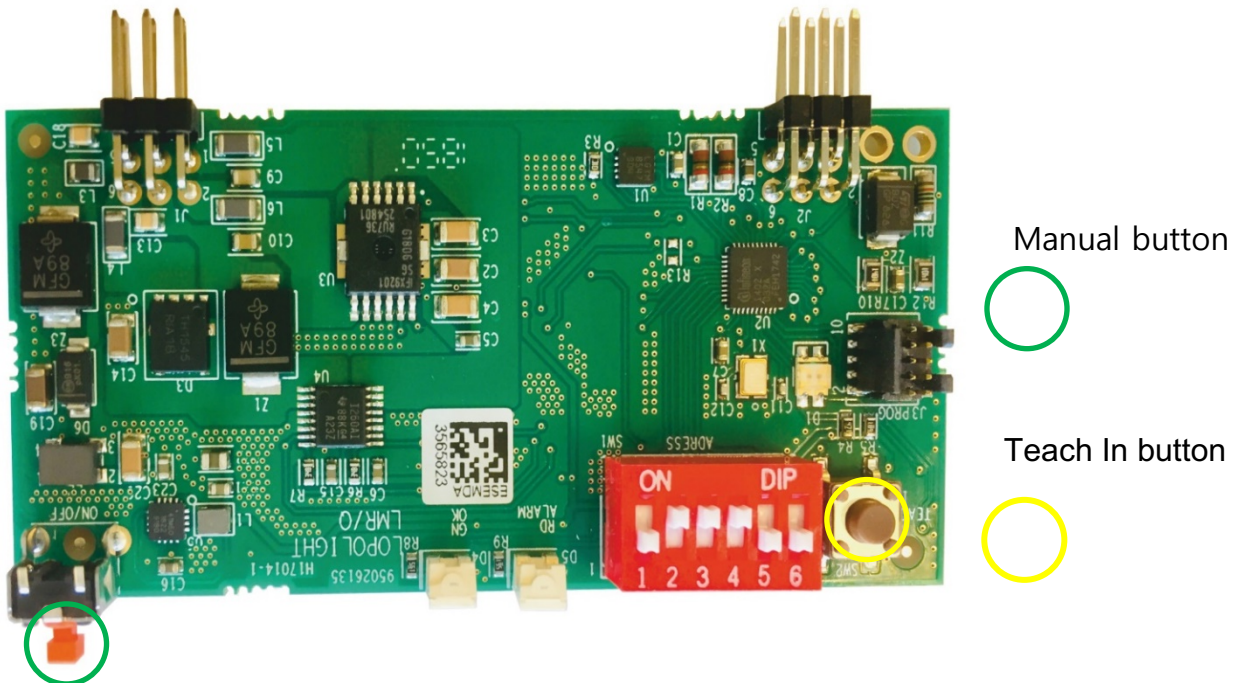



### **6.3 Manual control:**

Every navigation light is connected to an individual monitoring relay (LMR/Q) in the NLC. Each LMR/Q carries a manual/Emergency control button labelled "ON/OFF", two status LEDs (Green = ON, red = alarm). Using the manual/emergency on/off button the lights can be controlled directly from the LMR/Qs, however if a mimic panel is connected and active, an alarm will sound as the command was not sent through the system to operate the light in question. To avoid this, simply disconnect the RS485 connection between the motherboard and the TCP/IP Server panel before utilizing manual control.

### **6.4 Factory reset:**

If a factory reset is needed, this can be performed from the password protected part of the Lopolight software. This process should only be performed by a trained technician. please refer to the "Graphical interface software manual".

### **6.5 Setting the address of the LMR/Qs:**

Each individual LMR/Q must be assigned an individual address used by the RS-485 network in order to respond to commands sent from either the control panel or an external device.

When a system is delivered from Lopolight, all LMR/Qs has already been set up with their corresponding addresses.

Address 1 through 60 are all legal. Whereas address 0 (zero) is NOT.

Address 61 through 64 are reserved for the group keys, but in special circumstances these can be used for individual lights if LMRs or LMR/Qs are installed for this.

The addresses are set using binary logic on the small dip-switch on the LMR/Q.

DIP switches

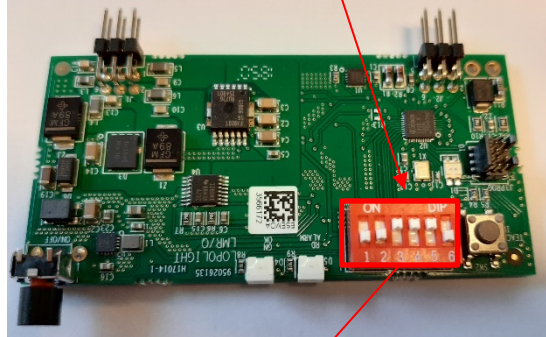

On position

Off position

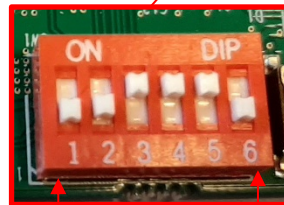

Sw 1

Sw 6

The following table shows the configuration of the LMRs for each position.

Position	Sw 1	Sw 2	Sw 3	Sw 4	Sw 5	Sw 6
1	On					
2		On				
3	On	On				
4			On			
5	On		On			
6		On	On			
7	On	On	On			
8				On		
9	On			On		
10		On		On		
11	On	On		On		
12			On	On		
13	On		On	On		
14		On	On	On		
15	On	On	On	On		
16					On	
17	On				On	
18		On			On	
19	On	On			On	
20			On		On	
21	On		On		On	
22		On	On		On	

23	On	On	On		On	
24				On	On	
25	On			On	On	
26		On		On	On	
27	On	On		On	On	
28			On	On	On	
29	On		On	On	On	
30		On	On	On	On	
31	On	On	On	On	On	
32						On
33	On					On
34		On				On
35	On	On				On
36			On			On
37	On		On			On
38		On	On			On
39	On	On	On			On
40				On		On
41	On			On		On
42		On		On		On
43	On	On		On		On
44			On	On		On
45	On		On	On		On
46		On	On	On		On
47	On	On	On	On		On
48					On	On
49	On				On	On
50		On			On	On
51	On	On			On	On
52			On		On	On
53	On		On		On	On
54		On			On	On
55	On	On			On	On
56			On		On	On
57	On		On		On	On
58		On	On		On	On
59	On	On	On		On	On
60			On	On	On	On

Table 1

\* See explanation below

The numerical values for each Sw is binary, thus giving each bit the following values for addresses;

- Sw 1 = Binary1
- Sw 2 = Binary 2
- Sw 3 = Binary 4
- Sw 4 = Binary 8
- Sw 5 =Binary 16
- Sw 6 = Binary 32

## 7.0 Spare parts:

### Lopolight P/N: Name:

400-018/Q	LMR/Q card
600-917	115/240 VAC Phoenix power-supply
600-918	24/24 VDC Phoenix power-supply
600-927	Circuit-breaker (20A) for 24VDC
600-928	Circuit-breaker (6A) for 115/240VDC
600-930	3-pin plug for navigation light connection in NLC
900-733	Ground strap for NLC enclosure (15 cm mesh)
500-150	TCP/IP web server
500-151	TCP/IP alarm client
800-145	NLC to mimic panel Power cable with buzzer
800-146	NLC to TCP/IP server cable
601-120	USB- type A to USB type A cable, 5 meters
601-121	HDMI to HDMI cable, 5 meters
601-122	DisplayPort to HDMI cable, 5 meters

## 8.0 Replacing power supplies in the NLC

Unplug all connectors on power-supplies. (2\*3 pieces). Do not disconnect wires from plugs.

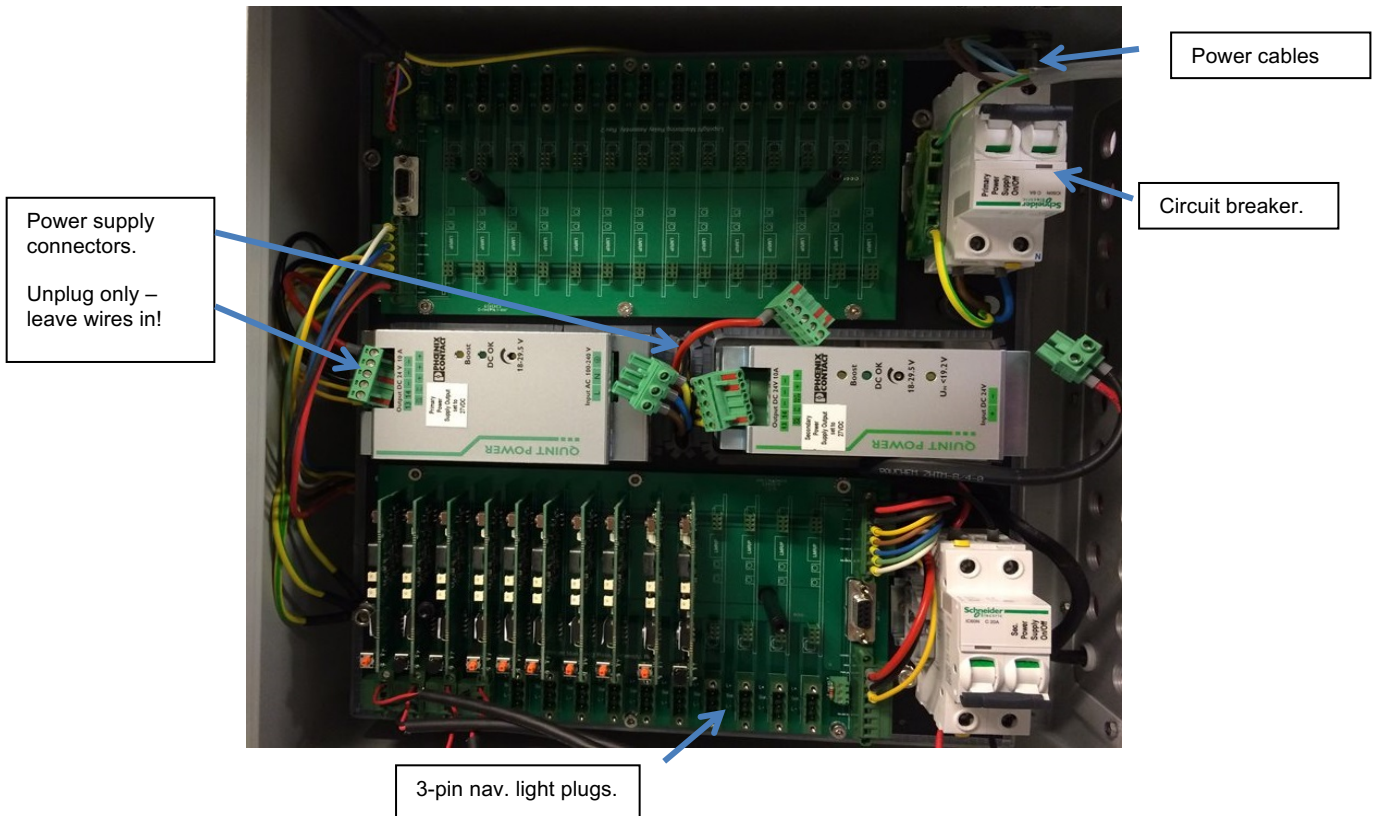

Remove four pieces 6mm in hex-type bolts and washers. Note earth connections.

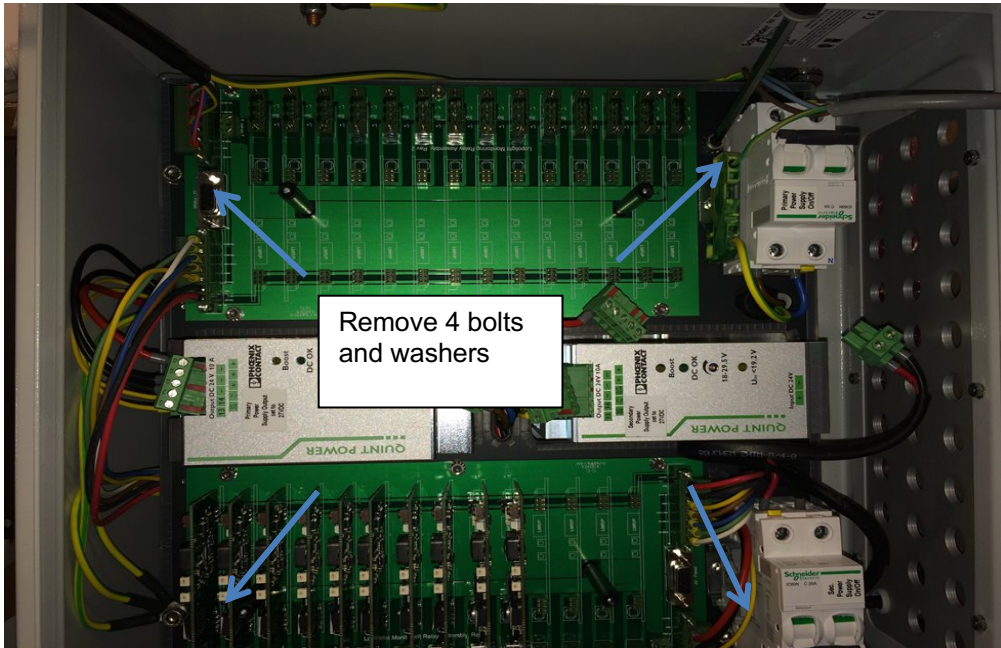

Pull middle plate off – gently. All power connectors will follow plate.

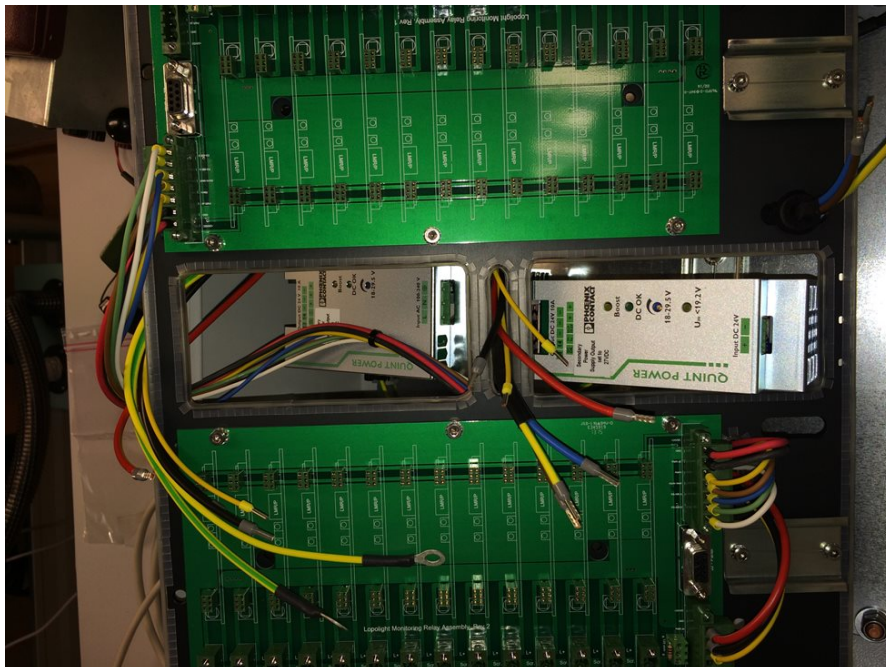

Change the faulty Power-supply unit (remove by releasing DIN-rail bracket under the power-supply unit)





Reinstall middle plate. Remember the earth connections under one of the bolts.

Reinstall cables and plugs.

## 9.0 Replacing LMR card

9.1 Open the door of the NLC using the handle.

9.2 Turn off supply voltage for the NLC, simply by setting the circuit breaker(s) in the off position.

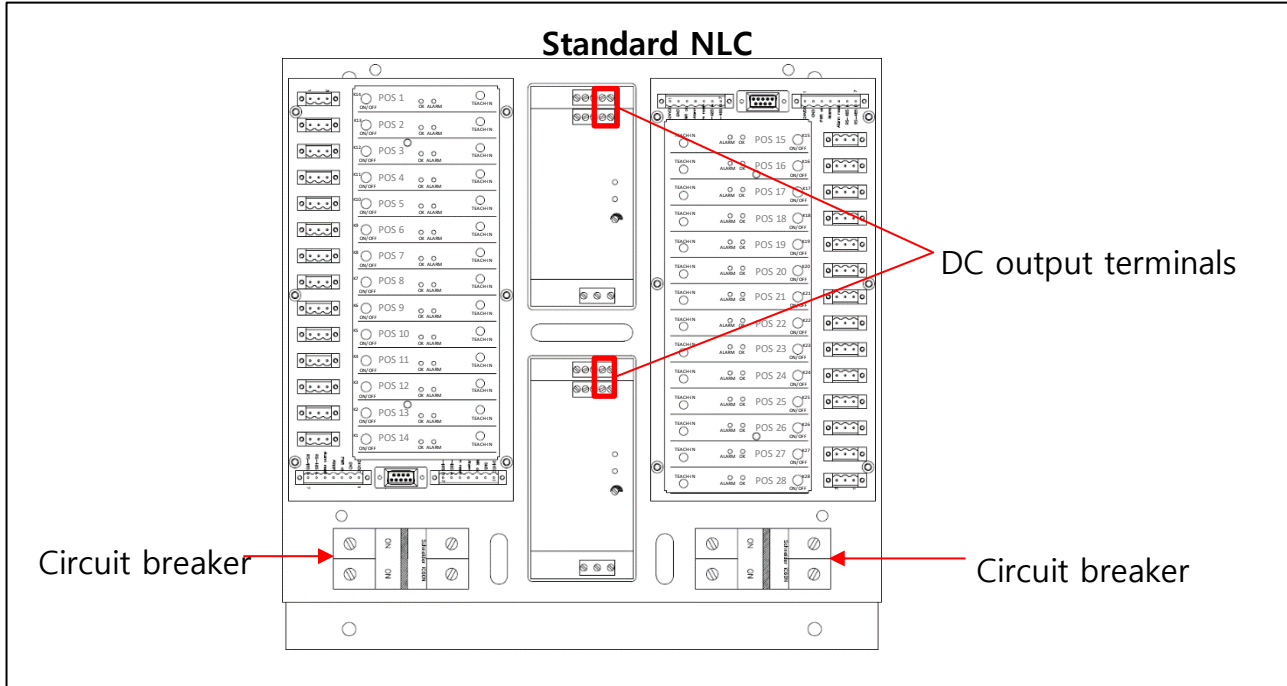

9.3 Remove the two finger screws fastening the cover of the LMRs.

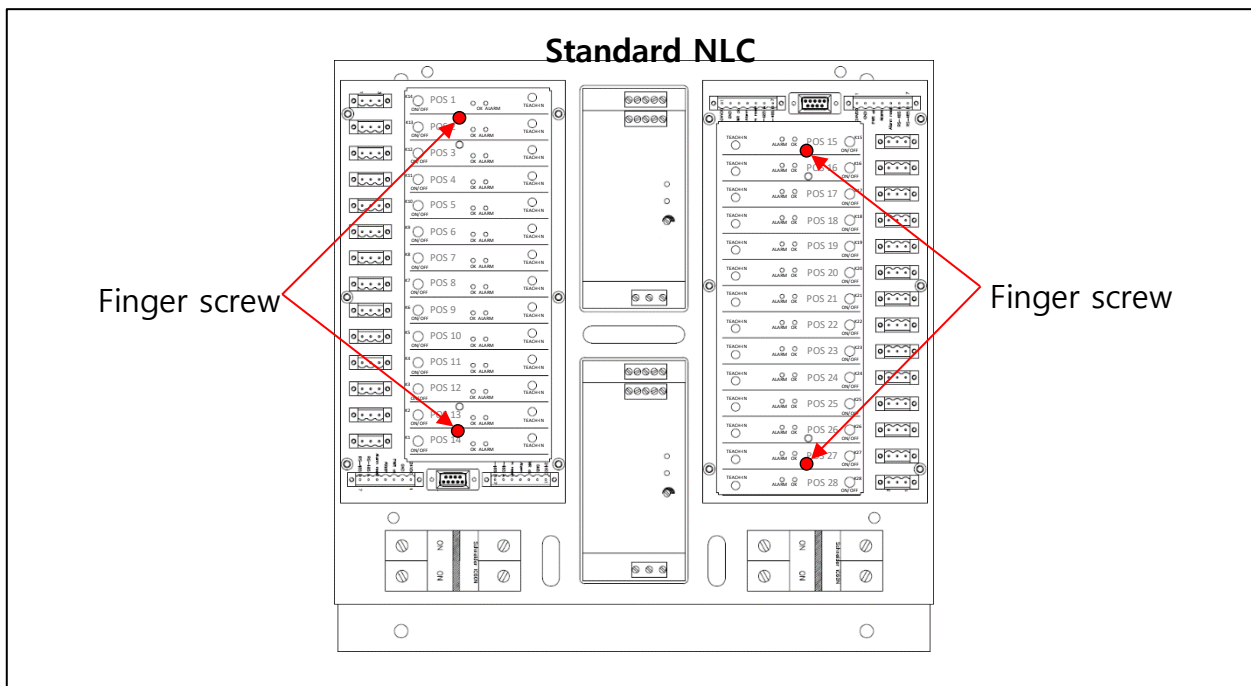



9.4 Remove the two screws holding the LMR retainer in place using a 3mm hex key.

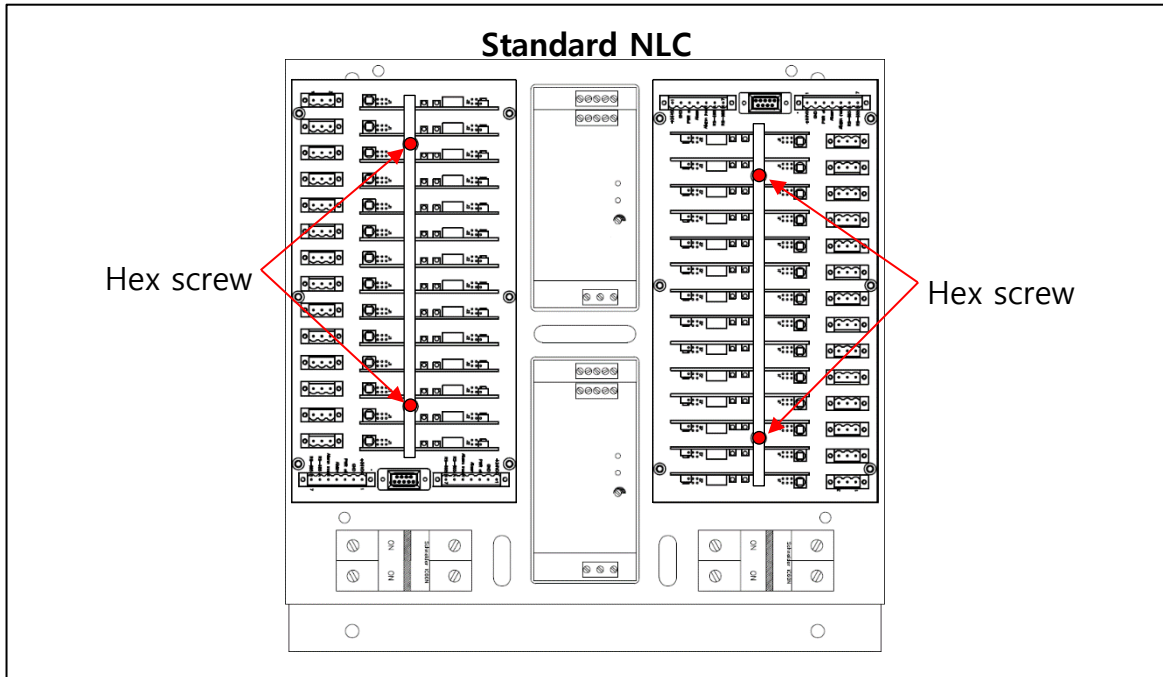

9.5 Remove the LMR retainer keeping the orientation in mind as installing it with the wrong orientation may cause issues.

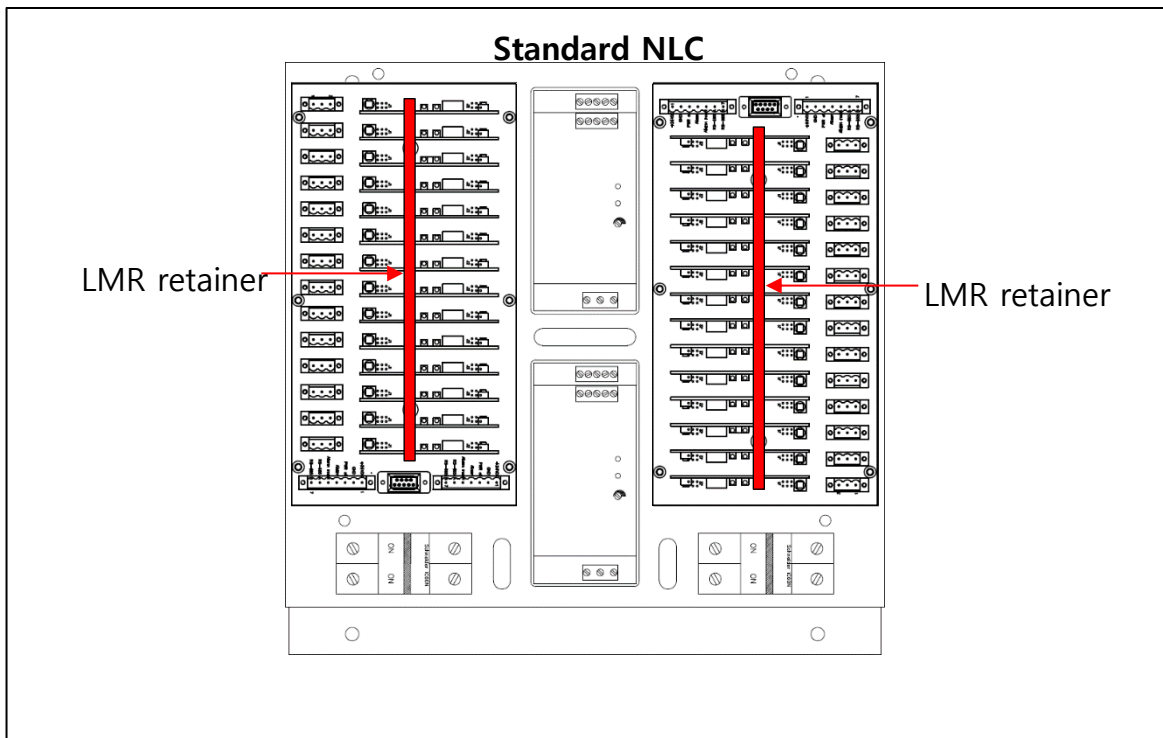

**9.6** Remove the LMR in question by pulling it out of the NLC. The position number can be found on the LMR cover in case of doubt.

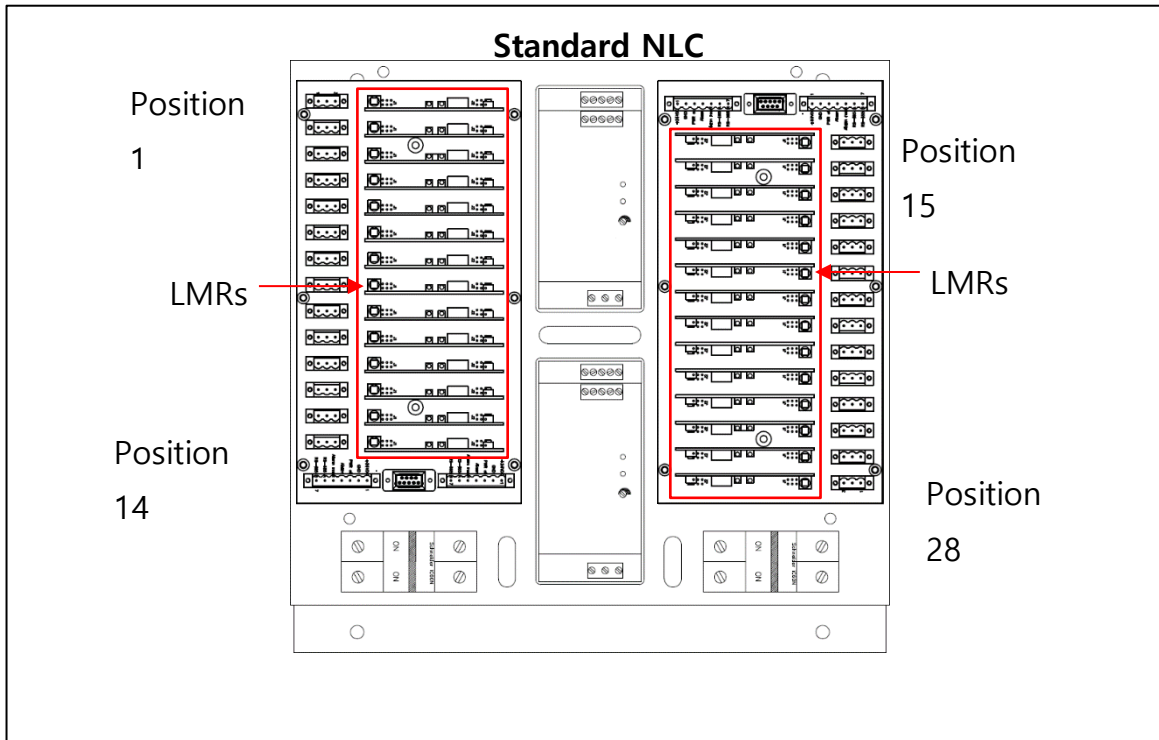

- 9.7** Set the new LMR with the correct address (Refer to section 9.3 in this manual to setup of the LMR cards)
- 9.8** Insert the new LMR in the correct position in the NLC and assemble in reverse order.  
NOTE! Make sure all the pins on the LMR are correctly inserted into the connector on the motherboard!
- 9.9** Apply power to the system and switch the light connected to the replaced LMR on. (Alarm may sound)
- 9.10** Wait 35 seconds and then perform the "teach-in" procedure (Refer to section 6.4 in this manual on how to perform "teach-in" procedure) on the LMR, letting the LMR register the power values of the light on the LMR for monitoring purposes.
- 9.11** The system is now ready for normal operation.

## 10.0 Troubleshooting guide and instructions

### Error indications on LMR cards (in NLC)

Situation: (one) navigation light supposed to be on – activated either from panel or manual/emergency switch

Line:	Error indication:	Possible reason	Fault finding action: Check if OK	Action if NOT ok	Reference in manual:
1	Green OK indicator not active	Navigation light faulty	Navigation light illuminates	Check if navigation light works	Section 15.1 P45
2	Red alarm indicator illuminated (1)	Missing "Teach-in"	Perform Teach-in	Line 3	Section 6.3 P20
3	Red alarm indicator illuminated (1)	Navigation light faulty	Navigation light connection/function	Change navigation light if proven faulty	Section 15.1 P45
4	Center-indicator orange (1)	Short circuit in cable to navigation light (Current limiter is in function)	Check cabling/connections/connectors	Go to line 5	
5	Center-indicator orange (2)	Short circuit in navigation light (Current limiter is in function)	Navigation light connection/function	Change navigation light if proven faulty	Section 15.1 P45
6	Center-indicator is blinking orange after pressing teach-in button	Teach-in procedure running (some 5 seconds)	No action. Not an error	--	--
7	Center-indicator is <u>NOT</u> blinking orange after pressing teach-in button (1)	Navigation light not connected to output terminals (or not using any current)	Navigation light connection/function	Check functionality of navigation light	Section 15.1 P45
8	Center-indicator is <u>NOT</u> blinking orange after pressing teach-in button (2)	LMR faulty	Replace LMR (Remember dip-sw. settings AND teach-in procedure)	--	Section 13.0 P34
9	Alarm on panel. Navigation light not on. LMR: Center-indicator blinking green AND no indications on Green/red front indicators.	Navigation light activated on panel – but switched off at manual/emergency button on LMR	Switch on at LMR (press manual/emergency button once)	--	Section 8.0 P23
10	Center-indicator constant red	Navigation light failure	Navigation light connection/function	Change navigation light if proven faulty	Section 15.1 P45
11	Center-indicator blinking green slowly AND front indicator constant green	Navigation light will expire within 2000 hours	Change navigation light when convenient	--	--
12	Center-indicator alternating red/green AND front indicator constant red	Navigation light has expired it 50.000 hour lifetime	Change navigation light as soon as possible.	--	--

### 11.0 Exploded view of the box with the monitoring relay

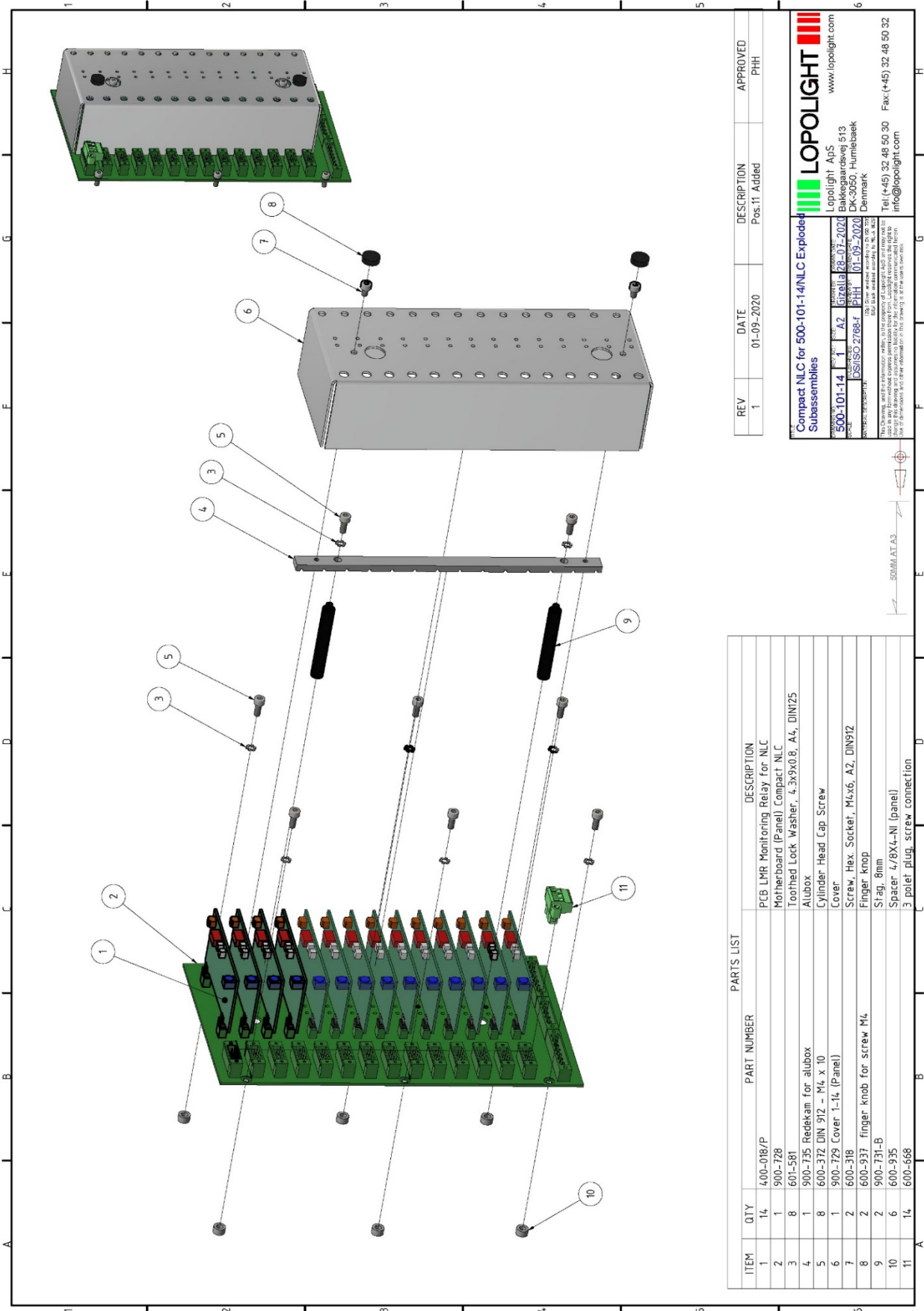

Lopolight contact information:

**Corporate office**

Lopolight ApS  
e-mail: [info@lopolight.com](mailto:info@lopolight.com)  
Phone: +45 32 485 030

**Northern Europe**

Sales manager  
Mike Booth  
e-mail: [mike@lopolight.com](mailto:mike@lopolight.com)  
Phone: +44 131 285 3307

**Southern Europe**

Sales manager  
Federice Verona  
e-mail: [federico@lopolight.com](mailto:federico@lopolight.com)  
Phone: +39 3315283830

**North America**

Sales manager  
David Hellar  
e-mail: [david@lopolight.com](mailto:david@lopolight.com)  
Phone: +1 215 847 5165